

Use of a commercial laser tracker for optical alignment

James H. Burge, Peng Su, Chunyu Zhao, Tom Zobrist
College of Optical Sciences, University of Arizona, Tucson, AZ 85721

ABSTRACT

Laser trackers have been developed that project laser beams and use optical systems to provide three dimensional coordinate measurements. The laser trackers incorporate a servo system to steer a laser beam so that it tracks a retro-reflector, such as a corner cube. The line of sight gimbals angles and the radial distance to the retroreflector are used to determine the coordinates of the retroreflector relative to the tracker. In this paper, we explore the use of the laser tracker to define the metrology for aligning optical systems, including the use of mirrors and windows. We discuss how to optimize the geometry to take advantage of the tracker's most accurate measurements. We show how to use the tracker for measuring angles as well as points.

Keywords: Optical alignment, laser metrology, optical testing

1. INTRODUCTION

The laser tracker was developed as a portable coordinate measuring machine that can measuring large or irregular structures¹ as well as complicated motions for multi-axis robotic machines.² We have found this device to be extremely useful for defining coordinates for aligning optical systems. The laser tracker uses two gimbal angles plus a radial measurement to determine the position of a retroreflector. The radial dimension can use an absolute distance measurement ADM or a distance measuring interferometer DMI. The ADM is most flexible and is easiest to use because the tracker can look from one target to the next. The DMI is most accurate (sub-micron) but this requires continues motion without blocking the laser beam. In this mode, the tracker measures only the change in position of the retroreflector.

The laser tracker is especially useful for optical alignment for 3 reasons:

- Accuracy : The laser tracker can make measurements to ~10 μm accuracy without any special geometry or data processing. By choosing advantageous geometry, calibrating repeating errors, and average random errors, the track can measure to < 1 μm .
- Flexibility: The laser tracker can measure over a wide range of angles and distances. As we discuss below, the tracker can measure through mirrors and windows. So most difficult geometries can be measured with the laser tracker.
- Ability to measure different optical spaces: Frequently optical systems incorporate fold mirrors to help with the system packaging. The laser tracker beam is also reflected by the mirrors, so the tracker can determine optical coordinates directly.

This paper discusses the use of the laser tracker for performing alignment of optical systems, which builds on experience with these systems already published.³ We give some background to laser trackers and discuss the performance for currently available systems in Section 2. The use of laser trackers for initial assembly of optical systems is discussed in Section 3. The ability to perform metrology through reflections from plane mirrors and through windows provides unique advantages to using the laser tracker for metrology, as discussed in Section 4. The laser tracker measures position of the retroreflectors. The system can also be used for measuring angle if an auxiliary mirror is used. This is discussed in Section 5.

*jburge@optics.arizona.edu; phone 520-621-8182, fax 520-621-3389

2. COMMERCIAL LASER TRACKERS

A laser tracker as a coordinate measuring machine has built on experience with tracking systems for observing moving targets,⁴ the use of DMIs with triangulation⁵, and surveying instruments.⁶ The laser tracker operates by steering a laser beam to home in on the reflection from a retroreflector, adjusting and measuring the two gimbal angles. The position of the retroreflector is then calculated from the knowledge of the two angles and the distance. The components of the laser tracker are shown in Figure 1.⁷

The laser tracker uses a sphere mounted retroreflector (SMR), which consist of a corner cube reflector made carefully so the apex of the mirrors coincides with the center of curvature of a precision tooling ball. (See Figure 2.) These tracker balls then provide a well defined interface between the optical measurement from the tracker and the mechanical system being measured.

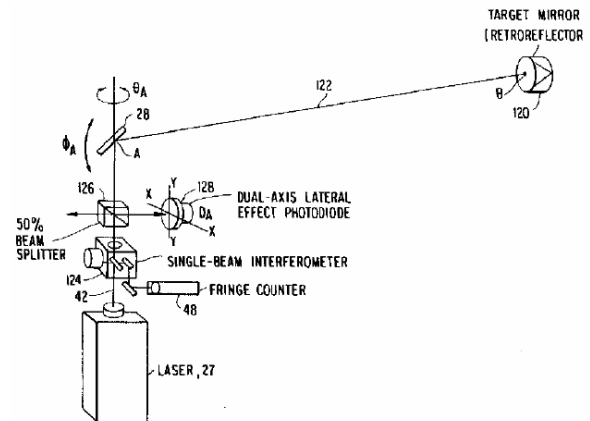

Figure 1. Laser tracker components, from US Patent #4,714,339.

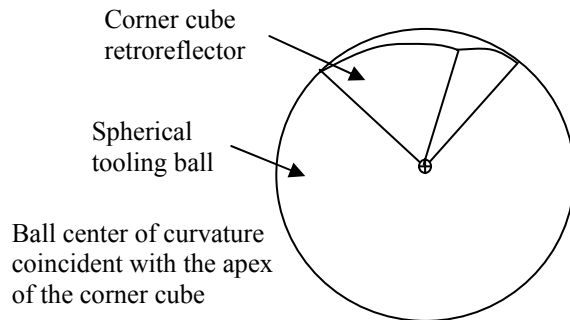

Figure 2. The laser tracker view reflections from SMRs (Sphere Mounted Retroreflectors) or “tracker balls”. These provide an optical reference for the laser tracker and provide a mechanical interface. The tracker measures the location of the center of curvature of the SMR.

The laser tracker measures radial distance r one of two ways: with Absolute Distance Measurement (ADM) or relative distance mode using distance measuring interferometry (DMI). In ADM, the laser tracker uses a proprietary time of flight measurement technique, which may use a different wavelength than the tracking laser. This method is less accurate than the DMI, but does not require a known starting point to calculate the radial distance and it does not require continuous measurements. For operation with the DMI, the SMR must first be locked onto by the laser tracker to establish its initial location. This is usually accomplished by starting with the SMR in the “home” (typically referred to as the “bird-bath”), which is a known reference point on the body of the laser tracker. Once the initial SMR location has been established, the SMR can be carefully moved to another location, and provided the laser tracker stays locked onto the SMR, the DMI will calculate the change in position. If the laser beam between the laser tracker and the SMR is “broken”, then the SMR home position must be reestablished. This is the main limitation with using DMI mode.

Because a laser beam is used to calculate the radial distance r between the laser tracker and the SMR, the refractive index of the air n through which the laser beam is propagating must to accurately known, as well as the wavelength of the laser light λ . These values are related by the expression $r = N(\lambda / n)$, where N is the number of wavelengths of light measured by the DMI. For the system we are using, $\lambda \approx 633$ nm, and it is stable to $\Delta\lambda \sim 0.01$ ppm/24 hours. The index n is a function of temperature, humidity and barometric pressure in the measurement environment. Changes in either λ or n will affect the measurements and provide sources of error for the measurements. The drift in the laser wavelength $\Delta\lambda$ is considered small enough to be negligible, so it is not automatically compensated by the laser tracker. The laser

trackers often include a weather station to measure temperature, pressure and humidity and automatically calculate the index n . Imperfect calibration and spatial variations in temperature will cause in errors in the radial measurement.

The angular performance of the laser tracker is less accurate than that of the radial performance due to effects of air motion and limitations in the encoder accuracy and sensitivity. The three dimensional accuracy for measuring the position of the SMR is typically limited by the angular measurements. For precise measurements, we optimize the geometry so that the most important measurement direction coincides with the radial direction for the tracker, which achieves the highest accuracy.

At the time of this writing, there are three major manufacturers of laser trackers: Automated Precision Inc. (API)⁸, Faro Technologies Inc.⁹, and Leica Geosystems¹⁰ (owned by Hexagon Metrology). Each manufacturer produces laser tracker models that are capable of measuring in both DMI and ADM modes. Each model laser tracker has strengths and limitations that may be important for different applications. API produces the smallest and lightest trackers, but they require firm mounting to maintain their performance due to extreme sensitivity to the vibrations and torque of their own internal motors. The Leica trackers on the other hand are the largest and heaviest, but are insensitive to small vibrations, allowing them to free-stand and be easily moved between measurement positions. The Leica laser trackers have the coarsest measurement resolution (1.3 microns in DMI and 0.14 arcsec in angle), while Faro trackers have the finest measurement resolution (0.16 microns in DMI and 0.02 arcsec in angle) but the shortest measurement range (0-35 meters), and the API tracker has the longest measurement range (>60 meters). The cost of the units is comparable and depends strongly on features. We provide a comprehensive comparison for laser trackers from the three companies in Table 1. We have performed exhaustive testing for all three trackers and conclude that the systems generally meet their specifications when they are properly supported and calibrated. However, they are sensitive machines that are susceptible to small problems that limit performance.

Table 1. Comparison of laser trackers available at the time of this publication.

	API Tracker 3⁸	Leica LTD 640¹⁰	Faro Tracker Xi⁹
<u>Physical Parameters</u>			
Tracker Head Height	14 inches	34.5 Inches	21.75 inches
Tracker Head Weight	19 lbs	75.2 lbs	48 lbs
<u>Measurement Envelope</u>			
Azimuth	640° (± 320°)	470° (± 235°)	540° (± 270°)
Elevation	+ 80° - 60°	± 45°	+75° - 50°
Distance (radial)	> 60 meters	0-40 meters	0-35 meters
<u>3D Accuracy</u>			
Accuracy of a Coordinate	± 5 μm/m	± 10 μm/m	18.1 μm + 3.0μm/m
<u>DMI (Interferometer) Performance</u>			
Accuracy of DMI	1 μm/m	± 10μm ± 0.5μm/m	1.8μm + 0.4μm/m
Distance repeatability	± 2.5 μm/m	± 2 μm	± 1 μm
Resolution	1μm	1.26μm	0.158μm
<u>ADM Performance</u>			
Accuracy of ADM	±15μm or 1.5μm/m, (whichever is greater)	± 25 μm (± 0.1mm @45° elevation)	± 9.8μm + 0.4μm/m
Distance repeatability	± 25μm	± 12μm	± 1μm + 1μm/m
Resolution	1μm	1μm	0.5μm
<u>Angular Performance</u>			
Resolution	0.07 arcsec	0.14 arcsec	0.02 arcsec
Repeatability	2.5 μm/m	7.5 μm + 4 μm/m	2 μm + 2 μm/m
Accuracy (Static)	5 μm/m	15 μm + 6 μm/m	18μm + 3μm/m

3. DIRECT MEASUREMENT OF SURFACE AND POSITION

The laser trackers were developed to measure shapes of irregular surfaces and to measure coordinates of reference points for mechanical systems. These features are directly applicable for optical systems. We use the laser trackers for measuring aspheric surfaces and for initial assembly of optical systems.

3.1 Measurement of aspheric optical surfaces

By carefully controlling the geometry, the laser tracker can measure aspherical optical surfaces to $< 1 \mu\text{m}$ accuracy, as shown in Reference 11 and can achieve even better accuracy if carefully calibrated.¹² For these measurements, the tracker is supported near the center of curvature of the concave surface and the SMR is scanned across the surface. Since the tracker itself is near the center of curvature, the angular uncertainties couple weakly into the measurements. The radial direction is measured to high precision using the DMI mode, which provides accuracy of $\ll 1 \mu\text{m}$ in the radial direction, which nearly matches the surface normal. For the case where the tracker is located a distance h from the center of curvature of the mirror under test, the sensitivity of the radial measurement to angular measurement errors is derived in Reference 12 as

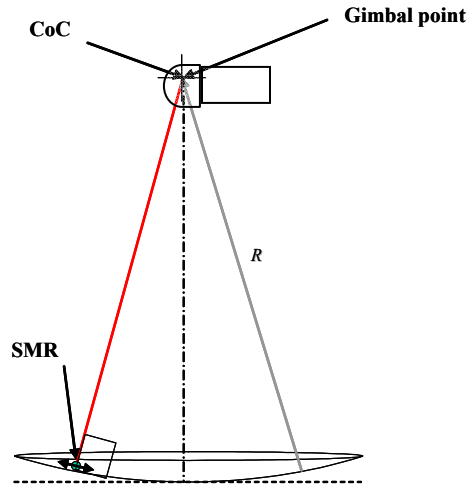

Figure 3. The laser tracker will accurately measure concave surfaces if the tracker is located near the center of curvature

$$\frac{dr}{d\theta} \cong \frac{x}{R}(R-h), \quad \text{Eq. 1.}$$

where x gives the off axis distance for the point being measured R gives the nominal radius of curvature.

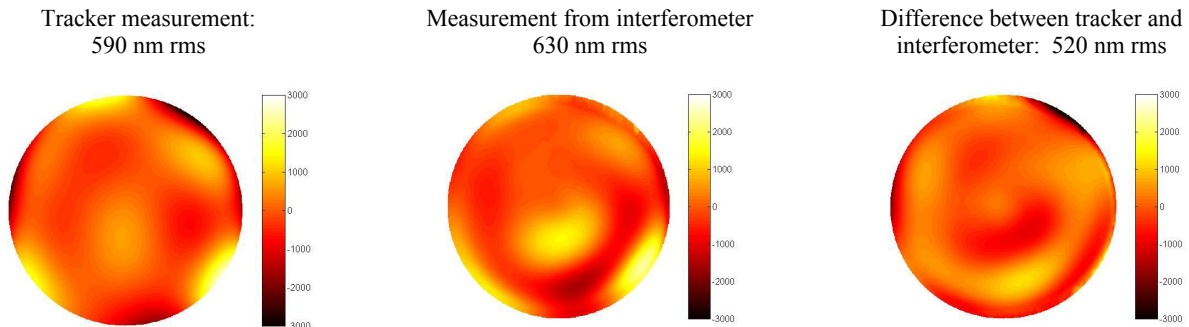

Figure 4. The laser tracker measurement of a 1.7-m diameter off axis aspheric mirror agrees to $0.5 \mu\text{m}$ rms with data from an interferometer. The low order terms of power, astigmatism and coma, which are strongly affected by alignment, were removed from this data. (Reprinted from Reference 11).

A more complicated system is under development which uses real time references that accommodate for changes in apparent radial shift and angular tilt of the line of sight using an auxiliary optical system.¹² This auxiliary system projects 4 DMI laser beams to fixed locations on the mirror being measured. At each location, a target is mounted to the mirror being measured which contains a lateral position sensing detector PSD and a retroreflector. The DMIs measure the apparent change in the surface's axial position and tilt. The PSDs sense the apparent pointing error for the optical

system. These errors will generally be caused by air motion in the line of sight path as well as motion of the tracker with respect to the surface being measured. The line of sight for this system is nearly coincident with that for the laser tracker, so the compensation based on these references is expected to provide significant improvement.

3.2 Coordinate measurement for optical systems

The laser tracker can be used directly for measuring the position of optical elements in a system as long as all degrees of freedom for the optics can be transferred to SMRs. A single SMR with known position with respect to the optic can be used to locate the position of this one point in space, but gives no information of rotation about any axis through the sphere. A second SMR with known position on the optic will fix a second point, but leaves rotation about the line defined by the two SMRs undefined. A third SMR fully constrains the position and additional SMRs provide redundancy.

As an example, consider the initial alignment of an off axis telescope such as the 1.7-m New Solar Telescope at Big Bear Solar Observatory.¹³ This system has complex geometry and is sensitive to misalignment. The mirrors can be positioned in the telescope to $< 50 \mu\text{m}$ accuracy using the laser tracker as a reference, as shown in Figure 5. The tracker can be mounted in the optical system so that it can view SMRs on the declination axis, the primary mirror, and the secondary mirror. As long as three or more SMRs are located accurately on each optic, the laser tracker can accurately guide the initial assembly and alignment.

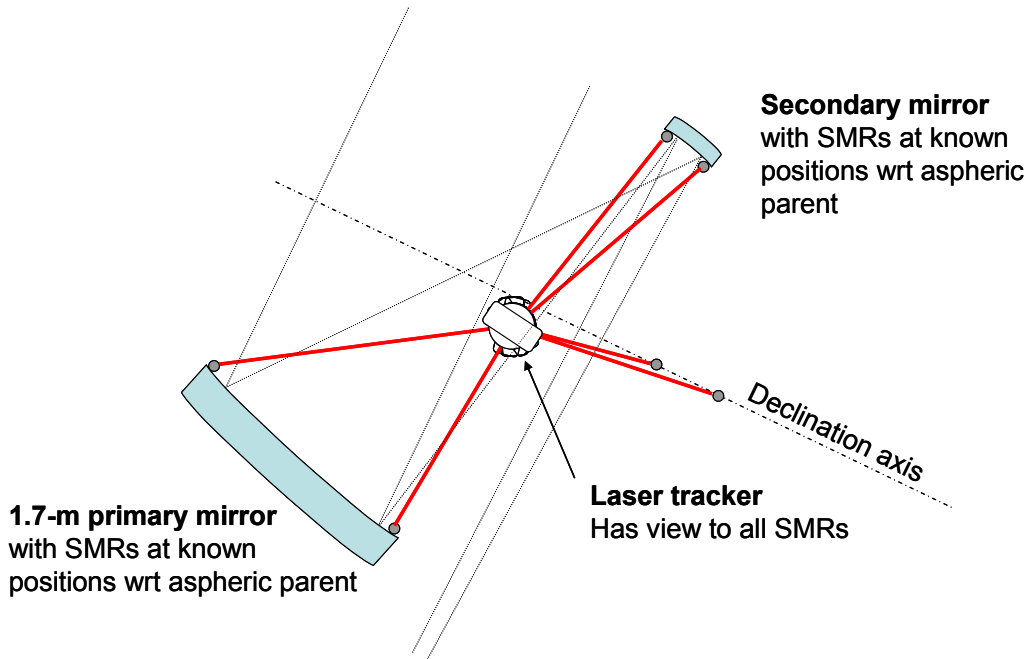

Figure 5. The mirrors for the New Solar Telescope can be assembled into the system using the laser tracker for metrology.

The position of the SMRs with respect to the optical surfaces can be determined when the optics are being measured in the optical shop. This requires SMRs or some other datum feature to be fixed to the optic. Then the position of the optical surface with respect to these SMRs or datum surfaces becomes a requirement for the optical surface measurement. This can usually be readily accomplished in the optical shop. For example, the measurement of the ellipsoidal secondary mirror above provides an accurate determination of the two focal points of the ellipsoid. The surface is measured with an interferometer at one focus and with a spherical mirror centered on the other, as shown in Figure 6.

The SMRs can be used as optical references in the same way that precision tooling balls are used. An optical system such as an interferometer or point source microscope can be set up so that the spherical wavefront is well aligned with the optical surface or system. Then the SMR can be inserted so that the converging wavefront is concentric with the spherical surface of the ball, as determined by the interferometer or point source microscope. The position of the SMR can be measured by the laser tracker.

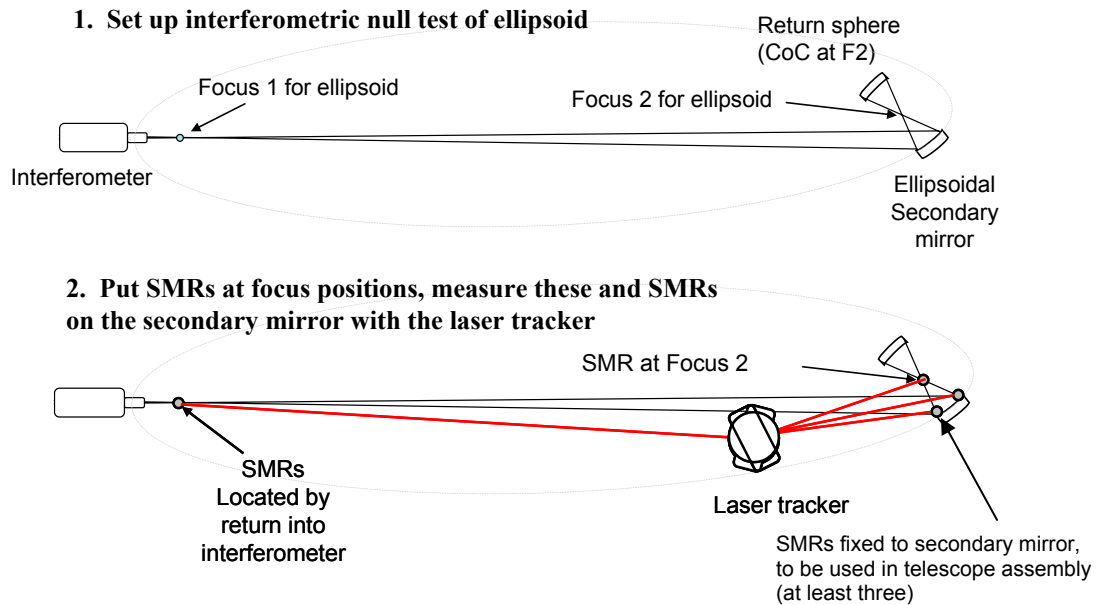

Figure 6. The position of reference SMRs can be established in the optical shop when the aspheric mirror is being measured. We show the optical test of the NST secondary mirror where the SMRs fixed to the mirror are located with respect to the focal points of the ellipsoidal surface.

4. MEASUREMENT THROUGH FOLD MIRRORS AND WINDOWS

As an optical system, the laser tracker can be used with the light reflected from flat mirrors or sent through optical windows. This provides some important advantages for optical system alignment.

4.1 Measurement through reflections from flat mirrors

Optical systems frequently use reflections from flat mirrors to fold the system to fit into available space. Such systems can be quite challenging to align, as there is no well defined axis and optical distances are hard to define. Since the laser tracker measures coordinates optically, it works very well for such systems. The laser tracker needs to be set up so that the laser beam is reflected by the same set of mirrors as the optical system being aligned. The tracker then measures the position of the reflected image, which corresponds exactly to the desired coordinates.

As an example, the measurement of the NST secondary mirror was performed as described above. However, the distance to the far focus was long enough that the complete test would not fit onto our optical table. No problem. A flat mirror was inserted to fold the test path. Then the laser tracker measurements were performed through this flat, as shown in Figure 7.

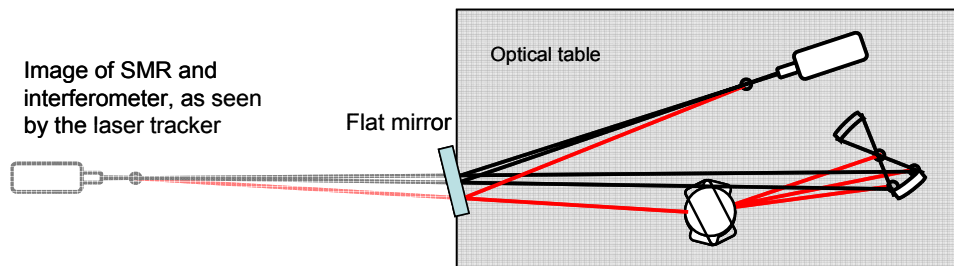

Figure 7. The NST test shown above was performed with the optical path folded. The laser tracker measures the image of the SMR from this mirror, which corresponds exactly to the optical position for the test. The actual position of the fold mirror is never determined.

The ability to perform accurate metrology for folded systems provides a true break-through for aligning optical systems. The use of plane mirrors is further described below in Section 5 where we use the tracker to determine the position and angle of the mirror. We also show data that confirms that the tracker measures through reflections from flat mirrors with no degradation in accuracy.

There is a potential for difficulty measuring through flat mirrors due to the change in polarization state when the light is reflected from metal film coatings. The DMIs typically use highly polarized light and the reflections can affect the state of polarization. We have not observed any such limitation, but we are aware of the possibility.

4.2 Measurement through windows

As a non-contact instrument, the laser tracker is capable of measuring coordinates through an optical window. This is quite valuable for systems that operate in a vacuum or even at cryogenic temperatures. The laser tracker can be set up so it looks through an optical window. As long as the refraction from the window is appropriately compensated, absolute and relative positions can be measured to the accuracy limits of the laser tracker.

This compensation for refraction requires good knowledge of the window thickness, orientation, wedge, and material. Snell's law is used to determine the path of the laser. The total optical path distance OPD for the laser is described as

$$OPD = \sum t_i n_i$$

where t is the actual geometric path length.

The path itself must be calculated from Snell's law. The apparent optical position as determined by the laser tracker gives the angle and total OPD. From this, the actual position can be determined. When the calculation is performed, it is important to use the true gimbal point for the tracker and to use the appropriate wavelength for the path length measurement. The tracker software performs coordinate transformations and may not read out in gimbal angles, and the wavelength for the ADM may be different than the HeNe DMI laser.

We performed tracker measurements to investigate the effects of the window. A Leica laser tracker was set up viewing an SMR fixed about 1.5 meters away. A 10 mm thick fused silica window was inserted between the tracker and the SMR and the apparent position was measured. The angle and position of the window relative to the tracker were then measured by scanning an SMR across the front surface. The wedge was measured previously with an autocollimator. The apparent position, corrected for the refraction effects, matched the absolute position to within 20 μm , which approaches the tracker accuracy.

4.3 Measurement through powered mirrors and elements

The tracker measures through flat mirrors and windows with plane surfaces. It is also possible to use the laser tracker with powered optics, but this is much more complex. These optics will generally cause power and astigmatism in the light incident on the retroreflector. It is possible to compensate a known amount of power and astigmatism with optics at the retroreflector. It would be difficult to make this compensation without degrading accuracy, but it provides another powerful application of the laser tracker for optical alignment.

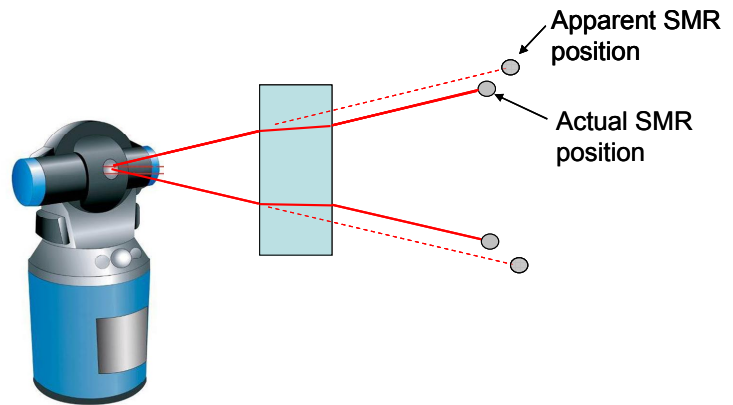

Figure 8. The laser tracker can measure through windows, but the laser path and OPD must be accurately compensated.

5. USE OF LASER TRACKER TO MEASURE ANGLE

5.1 Determination of normal direction for a plane mirror using laser tracker

The laser tracker measures positions of retroreflectors accurately, but it is limited in determining an object's orientation. It is possible to measure a body's 3-space position and orientation by measuring three SMRs fixed at known locations on the object. However, if the separation between the SMRs is small, the position uncertainty of the individual measurements from the tracker creates a relatively large uncertainty in the orientation.

As described above, laser trackers can measure images of retroreflectors from plane mirrors. The laser tracker can be configured to measure both the image of an SMR and the actual SMR in its true position. With the positions of these two measurements, the mirror is uniquely determined as the plane halfway between the two with its normal defined by the line connecting the two. This is shown in Figure 9.

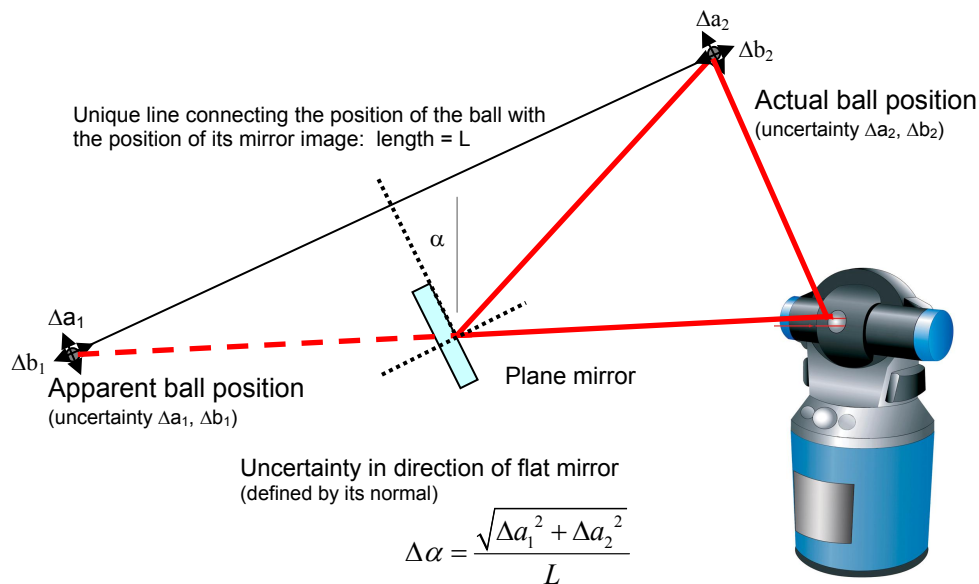

Figure 9. The laser tracker can measure the position of an SMR and the apparent position reflected by a plane mirror. The position and orientation of the plane mirror can then be determined.

The ability to determine the mirror position and normal direction was demonstrated with the Leica tracker and a 30 cm flat mirror. SMRs were measured directly and in reflection using ADM mode. (This requires the SMR to be rotated in its holder. We demonstrated repeatability for this of $< 1 \mu\text{m}$ and accuracy $\sim 5 \mu\text{m}$ limited by the manufacturing accuracy of the retroreflector and the ball.) The mirror position was also measured by sampling the surface directly in DMI mode. The agreement between the two measurements was about 2 arc-seconds, which is consistent with the noise in the data due to mirror motion when the surface was measured.

5.2 Determination of an objects three-space orientation using two plane mirrors

The three-space orientation of a body can be measured using this method with two mirrors, as long as the orientation of the body is known with respect to these mirrors. A single mirror gives no information about rotation about its normal. The second mirror actually over-determines the orientation (each surface normal constrains two directions in space) so a least squares fit must be performed to optimally reduce the data. The following procedure can be used for determining the object's orientation.

1. Two mirrors are mounted rigidly to the object. The mirror surface normals relative to the object must be accurately measured.
2. Two target SMRs are placed far away from the object such that the tracker can see each SMR directly and through reflection by one of the mirrors, as shown in Figure 10.

3. The tracker measures the positions of one SMR and its image through one of the mirrors, from which the mirror's surface normal can be calculated (see Figure 9). With increased separation of the SMR and its image, this angle measurement can be highly accurate.
4. Use the same method with a second SMR to determine the surface normal of the second mirror.
5. From the measured surface normals of the two mirrors in the object's coordinate and in the tracker's coordinate, perform a least squares fit to determine the object's angular DOFs in the tracker's coordinate.

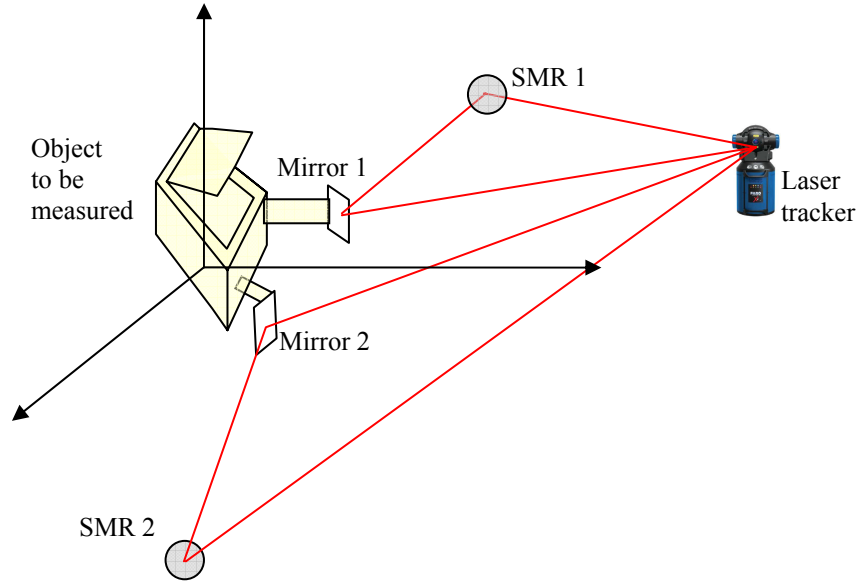

Figure 10. Schematic of the setup for measuring an object's angular degrees of freedom DOFs with a laser tracker, the two mirrors mounted on the object and two target SMRs far away from the object.

The laser tracker measures the 3D coordinates of any target with unequal accuracy, therefore, an optimal arrangement of the tracker, the target SMRs and the mirror is required to get best possible accuracy. Following is a nominal specification for tracker accuracy used for this analysis:

Angle measurement accuracy: $18\mu\text{m} \pm 3\mu\text{m/m}$

ADM distance accuracy: $10\mu\text{m} \pm 3\mu\text{m/m}$

Two extreme measurement configurations are shown in Figure 11:

Configuration 1: laser tracker, target SMR and the mirror surface normal are nearly co-aligned

Configuration 2: when reflection at the mirror is nearly grazing incidence

In Figure 12, we plot the measurement uncertainty of surface normal for the two configurations based on nominal performance specifications listed above. In either configuration, when L is fixed, increasing l always improves the measurement accuracy. Yet when l is fixed, the angle measurement accuracy degrades as L is increased.

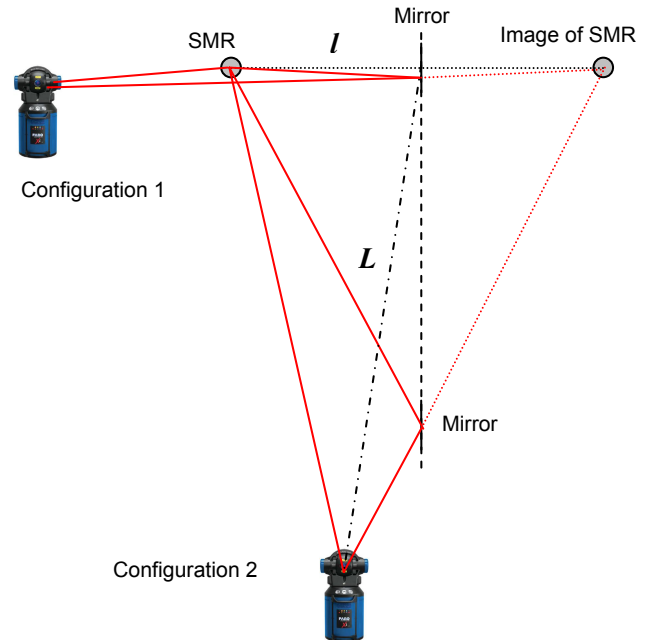

Figure 11. Definition of geometry for two extreme cases for measuring the normal direction. L is defined as the distance from the tracker to the mirror at the SMR-image bisect point. And l is defined as the half distance from the SMR to its image for a mirror using the laser tracker.

The accuracy of finding the three space orientation of the object depends on the relative orientation of the two mirrors as well as the ability to determine the normal for each mirror. The effect of this angle was determined by Monte Carlo simulation.

The geometry for this analysis follows the definition of the two mirrors mounted on the object as shown in Figure 13. We define the axes such that both mirror normals lie in the y - z plane and the z -axis bisects the angle created by the two mirror normal vectors.

In general, errors in the measurement of the two mirror surface normals can cause errors in determining the three axes directions. The errors are represented by three angles, θ_x , θ_y and θ_z defined as rotation between the measured and nominal x -, y - and z -axes, respectively. We assume equal uncertainties in the measurement of the mirror surface normals in two directions, and performed a Monte-Carlo simulation on the resultant errors θ_x , θ_y and θ_z . The results are plotted in Figure 14.

As expected, when the two mirrors are about parallel, $\Delta \approx 0^\circ$ or 180° , we have little sensitivity to measure the clocking about the surface normal direction. The sensitivity for measuring the rotation about the axis bisecting the two mirror surface normals is always good, independent of the angles between the normals. Optimal performance is obtained by placing the two mirror normal 90 degrees apart and 45 degrees on either side of the most critical direction of the object.

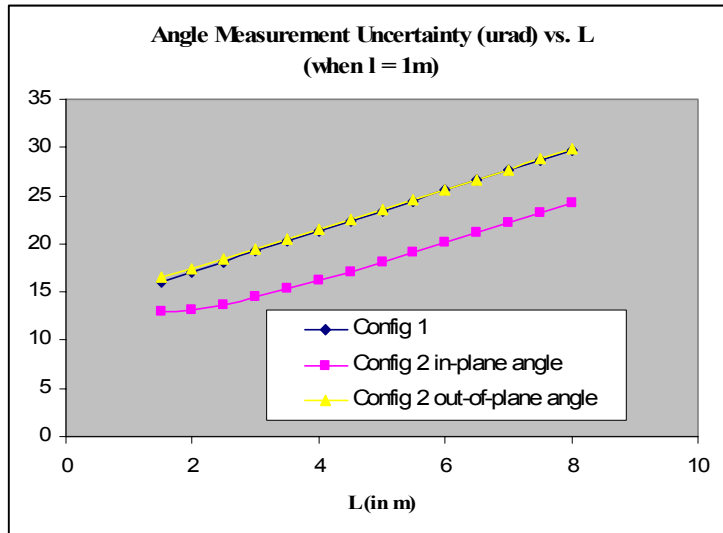
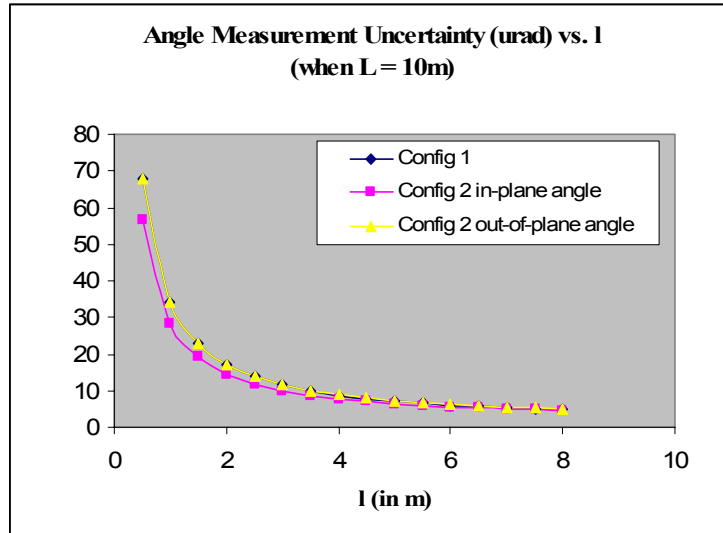

Figure 12. The angle measurement uncertainties in units of μrad for the two configurations illustrated in Figure 11, assuming nominal tracker angular and radial accuracy for (a) when tracker distance to plane mirror L is fixed, and (b) when SMR distance to mirror l is fixed.

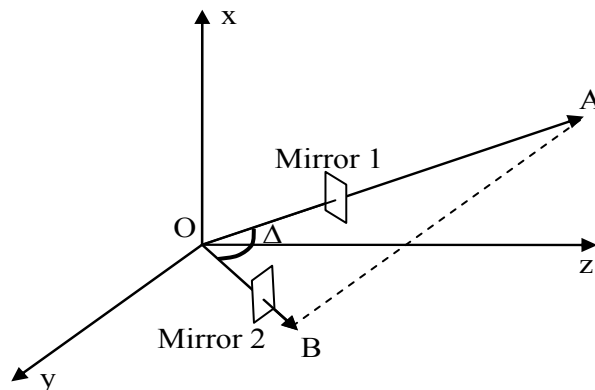

Figure 13. The measurement sensitivity of an object's orientation depends on the angle Δ between the two mirrors.

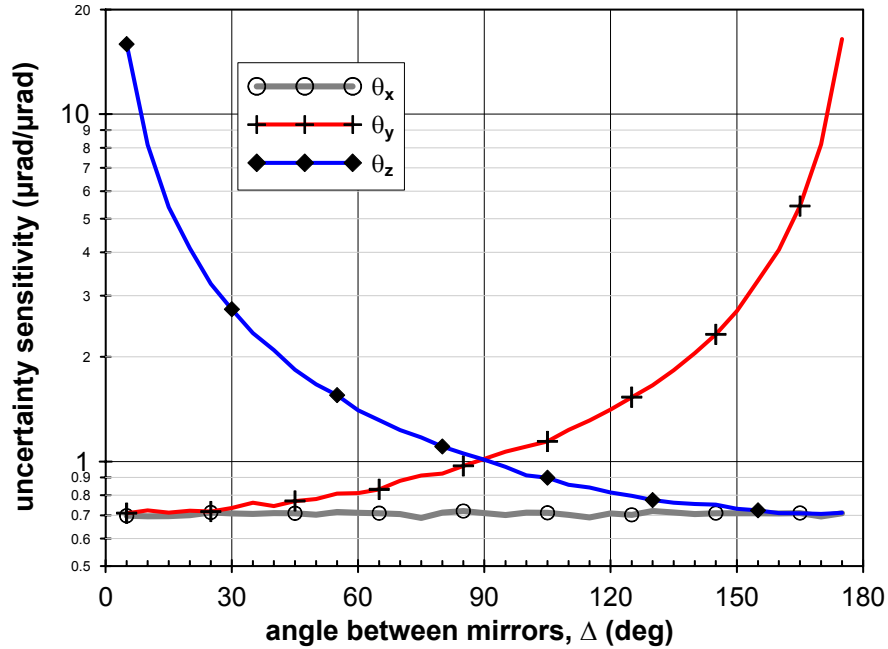

Figure 14. Monte Carlo analysis predicts the error in determination for each component of an object's orientation for the case where two mirrors with angle Δ between them are each measured with 1 μrad uncertainty.

5.3 Example application for orientation measurement using mirrors

We plan to use this method to measure the orientation of a computer generated hologram used in the optical test for the 8.4-m diameter off axis mirrors for the Giant Magellan Telescope.¹⁴ We use linear gratings on the CGH substrate as a reference to set the orientation of the mirrors. The linear gratings are made by electron beam lithography with sub-micron accuracy. We measure the angle of a mirror normal to a direction defined by the grating using an autocollimator and rhomboid prism. (The rhomboid prism provides small but constant angular deviation of the light which can be directed from the autocollimator alternately to the mirror or to the grating.)

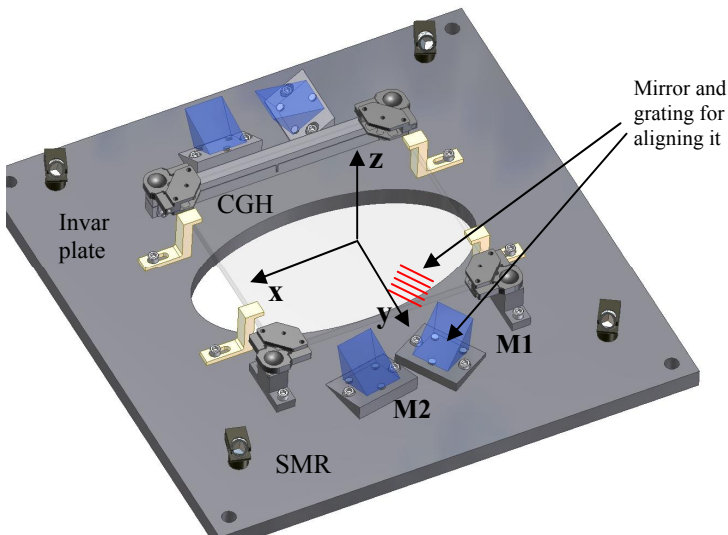

Figure 15. CGH mounting plate holds the computer generated hologram, SMRs, and mirror references. The mirror normals are aligned to the axis defined by gratings on the CGH substrate.

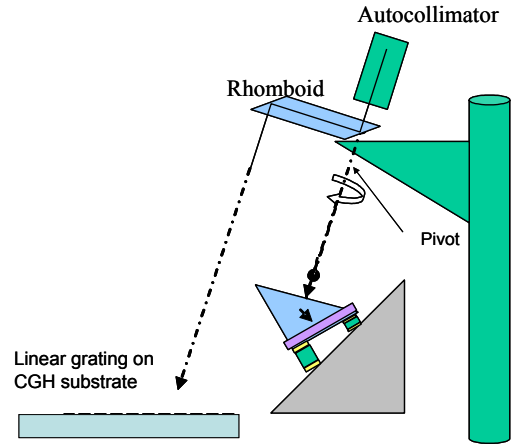

Figure 16. An autocollimator is used as feedback for aligning the mirror normal to the direction defined by the Littrow diffraction from the grating. A rhomboid prism is used to scan the autocollimator beam from the mirror to the grating.

Using reflections from the two mirrors, we will measure the orientation of the CGH to 12 μrad in tip/tilt and 20 μrad for clocking (rotation about the substrate normal). This would not be possible using only SMRs attached to the CGH.

6. CONCLUSION

Commercially available laser trackers are useful for assembling and aligning complex, precise optical systems. The good accuracy, portability, and flexibility are useful for measuring just about anything. The ability to measure along the line of sight through fold mirrors and windows is especially valuable for optical systems. We develop a technique here that shows how to use the laser tracker for measuring angular orientation as well as position.

As with many new things, the laser trackers are getting better each year and the costs follow the market trend. If these systems are sold in larger quantities, we would expect the performance to continue to increase and the cost to come *down*. Furthermore, we expect the systems to include additional features driven by needs from a new application. As optical technologists, we will continue to apply new optical features in ways that were not intended to provide high performance or additional flexibility for our tasks.

References

- 1) K. Harding, "Application issues when using optical 3D systems in place of CMMs," in *Machine Vision and Three-Dimensional Imaging Systems for Inspection and Metrology II*, K. Harding, Ed., Proc. SPIE **4567**, 1-10 (2002).
- 2) J. P. Prenninger, K. M. Filz, M. Incze, and H. Gander, "Real-time contactless measurement of robot pose in six degrees of freedom," *Measurement* **14**, 255-264, (1995).
- 3) B. B. Gallagher, *Optical Shop Applications for Laser Tracker Metrology Systems*, (M.S. Thesis, College of Optical Sciences, University of Arizona, 2003).
- 4) D. L. Patrick, "Sandia National Labs' precision laser tracking systems," in *22nd International Congress on High-Speed Photography and Photonics*, D. L. Paisley, Ed., Proc. SPIE **2869**, 822-826, (1997).
- 5) A. H. Greenleaf, "Self-calibrating surface measuring machine," *Optical Engineering*, **22**, (2) 276-280 (1983).
- 6) L. Fialovszky, *Surveying Instruments and their Operational Principles*, (Elsevier, Amsterdam, 1991).
- 7) K. C. Lau and R. J. Hocken, "Three and Five Axis Laser Tracking Systems," United States Patent 4,714,339 (1987).
- 8) <http://www.apisensor.com>
- 9) <http://www.faro.com>
- 10) <http://www.leica-geosystems.com>
- 11) H. M. Martin, J. H. Burge, S. D. Miller, B. K. Smith, R. Zehnder and C. Zhao, "Manufacture of a 1.7-m prototype of the GMT primary mirror segments", in *Optomechanical Technologies for Astronomy*, ed. E. Atad-Ettingui, J. Antebi and D. Lemke, Proc. SPIE **6273**, 62730G (2006).
- 12) J. H. Burge, T. Zobrist, L. B. Kot, H. M. Martin and C. Zhao, "Alternate surface measurements for GMT primary mirror segments", in *Optomechanical Technologies for Astronomy*, ed. E. Atad-Ettingui, J. Antebi and D. Lemke, Proc. SPIE **6273**, 62732T (2006).
- 13) C. Denker, *et al* , "Progress on the 1.6-meter New Solar Telescope at Big Bear Solar Observatory", in *Ground-based and Airborne Telescopes*, ed. L. M. Stepp, Proc. SPIE **6267**, 62670A (2006).
- 14) J. H. Burge, L. B. Kot, H. M. Martin, C. Zhao and R. Zehnder, "Design and analysis for interferometric testing of the GMT primary mirror segments", in *Optomechanical Technologies for Astronomy*, ed. E. Atad-Ettingui, J. Antebi and D. Lemke, Proc. SPIE **6273**, 62730M (2006).